

300A, 60/96V Single Channel Variable Frequency Drive for AC Induction Motors



Roboteq's RGIM18xx is a feature-packed, very-high-current, single channel controller for AC Induction motors. The controller can operate in one of several modes in order to sense the rotor position and sequence power on the motor's three windings in order to generate smooth continuous rotation. The controller also uses the Encoder information to compute speed and measure traveled distance inside a 32-bit counter.

The motors may be operated in open or closed loop speed or torque modes. The RGIM18xx features several Analog, Pulse and Digital I/Os which can be remapped as command or feedback inputs, limit switches, or many other functions. The RGIM18xx accepts commands received from an RC radio, Analog Joystick, wireless modem, or microcomputer. Using CAN bus, up to 127 controllers can be networked at up to 1Mbit/s on a single twisted pair.

Numerous safety features are incorporated into the controller to ensure reliable and safe operation. The controller's operation can be extensively automated and customized using Basic Language scripts. The controller can be configured, monitored and tuned in real-time using a Roboteq's free PC utility. The controller can also be reprogrammed in the field with the latest features by downloading new operating software from Roboteq.

Applications

- Electric vehicles
- Personnel carriers
- Golf cars
- Materials handling equipment
- Electric boats
- Automatic Guided Vehicles
- Agricultural robots

Features List

- 0-5V Analog, RS232 or TTL Serial, RS485 or Pulse (RC radio) command modes
- CAN bus interface up to 1Mbit/s with multiple protocol support
- Auto switch between serial, Analog, or Pulse based on userdefined priority
- Built-in dual 3-phase high-power drivers for one AC Induction motor at up to 300A
- Full forward and reverse control. Four quadrant operation. Supports regeneration
- Operates from a single power source
- Programmable current limit up to 300A for protecting controller, motors, wiring and battery
- Field Oriented Control
- Multiple Motor Operating mode
 - Open Loop Volts per Hertz
 - Fixed Slip Control
 - FOC Torque Mode
 - FOC Speed Mode
- Support for quadrature encoder
- RS485
- Accurate speed and Odometry measurement using encoder data
- Up to eight Analog Input for use as command and/or feedback
- Up to eight Pulse Width, Duty Cycle or Frequency Inputs for use as command and/or feedback
- Up to 10 Digital Inputs for use as Deadman Switch, Limit Switch, Emergency stop or user inputs
- Built-in Programming language for automatic operation and/or customized functionality
- Six general purpose 1A output for brake release or accessories. Two PWM capable outputs

- Selectable min/max, center and deadband in Pulse and Analog modes
- Selectable exponentiation factors for each command inputs
- Trigger action if Analog, Pulse or Encoder capture are outside user selectable range (soft limit switches)
- Open loop or closed loop speed control operation
- Closed loop position control with encoder, analog or pulse/frequency feedback
- Configurable Data Logging of operating parameters on Serial Output for telemetry or analysis
- Built-in Battery Voltage and Temperature sensors
- Regulated 5V output for powering Encoders, RC radio, RF Modem or microcomputer
- Programmable acceleration and deceleration
- Programmable maximum forward and reverse power
- Ultra-efficient 0.33 mOhm ON resistance MOSFETs
- Separate current sensors for Motor Amps and Battery Amps measurement
- Stall detection and selectable triggered action if Amps is outside user-selected range
- Overvoltage and Undervoltage protection
- Programmable Watchdog for automatic motor shutdown in case of command loss
- Overtemperature protection
- Diagnostic LED indicators
- Efficient heat sinking using conduction bottom plate
- Dustproof and weather resistant. IP56 NEMA rating
- Power wiring via high amperage power terminals
- 5.51" (140mm) L, 7.87" (200mm) W, 2.28" (58mm) H
- -40° to +85° C operating environment
- 6.48 lbs (2940 g)
- Easy configuration, tuning and monitoring using provided PC utility
- Field upgradeable software for installing latest features via the Internet

Orderable Product References

TABLE 1.

Reference	Number of Channels	Amps/Channel	Volts	Ethernet	Resolver/SSI
RGIM1860	1	300	60	No	No
RGIM1896	1	300	96	No	No

Important Safety Disclaimer

Dangerous uncontrolled motor runaway condition can occur for a number of reasons, including, but not limited to: command or feedback wiring failure, configuration error, faulty firmware, errors in user script or user program, or controller hardware failure.

The user must assume that such failures can occur and must make his/her system safe in all conditions. Roboteq will not be liable in case of damage or injury as a result of product misuse or failure.

Power Terminals Identifications and Connection

Power connections are made by means of high amperage power terminals located at the top of the controller, as shown in Figure 1.

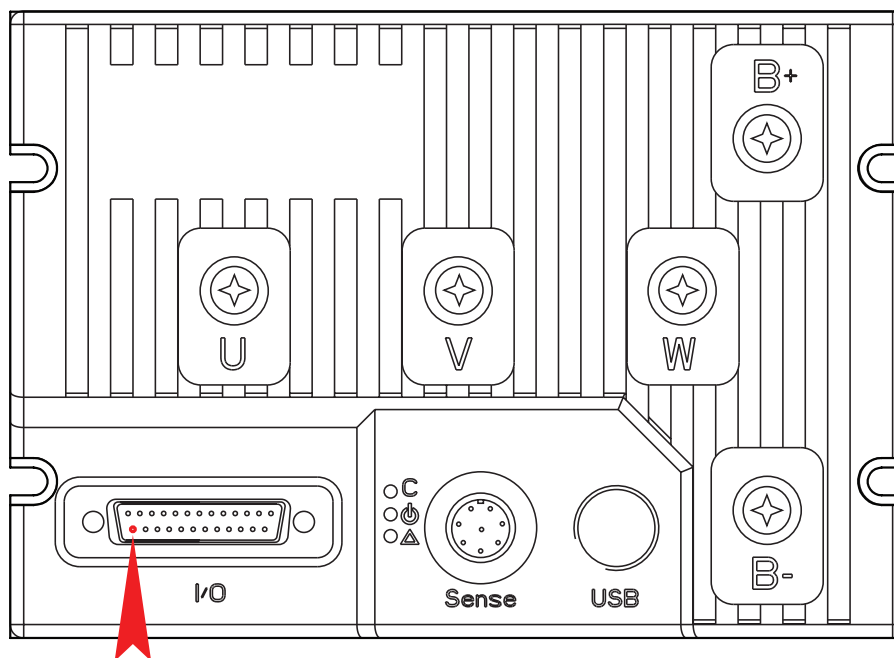

Warning: Properly identify PowerControl pin 25 before applying high voltage to it

FIGURE 1. Top Controller Layout

The diagram in Figure 2, below, shows how to wire the controller and how to turn power On and Off.

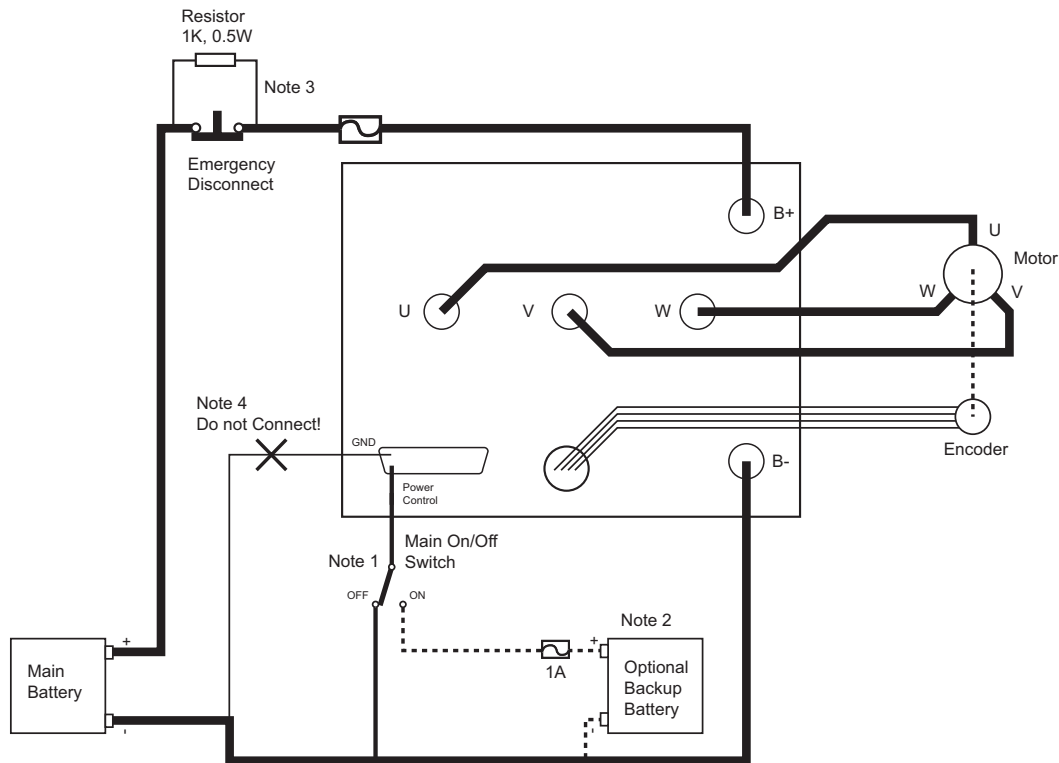

FIGURE 2. Powering the Controller. Thick lines identify MANDATORY connections

Important Warning

Carefully follow the wiring instructions provided in the Power Connection section of the User Manual. The information on this datasheet is only a summary.

Mandatory Connections

It is imperative that the controller is connected as shown in the above diagram in order to ensure a safe and trouble-free operation. All connections shown as thick black lines are mandatory. The controller must be powered On/Off using switch SW1 on the Power Control input.

Emergency Switch or Contactor

The battery must be connected in permanence to the controller's B+ terminal via a high-power emergency switch or contactor as additional safety measure. The user must be able to deactivate the switch or contactor at any time, independently of the controller state.

Electrostatic Discharge Protection

In accordance with IEC 61000-6-4, Roboteq Motor Controllers are designed to withstand ESD up to 4kV touch and 8kV air gap. This protection is implemented without any additional external connections required.

Some specifications, such as EN12895, require a higher level of protection. To maximize ESD protection, up to 8kV touch and 15kV air gap, you may connect the metallic heatsink of the controller to your battery negative terminal. [See App Note 062918 for example connections.](#)

Precautions and Optional Connections

Note 1: The power control (pin 25 on DSUB connector) must be grounded to turn off the controller. Floating the power control or connecting it to a battery will turn on the internal logic.

Note 2: A separate power supply may be used to power the controller's internal logic to keep the controller alive in case of voltage drop at the main battery because of motor load. **Voltage on Power Control pin must not exceed 30V Max. Make sure you correctly identified pin 25 before applying voltage to it.**

Note 3: Use precharge 1K, 0.5W Resistor to prevent switch arcing.

Note 4: Beware not to create a path from the ground pins on the I/O connector and the battery minus terminal.

Controller Mounting

During motor operation, the controller will generate heat that must be evacuated. The published amps rating can only be fully achieved if adequate cooling is provided. Additional conduction cooling is needed for high current operation and can be achieved by having the bottom side of the case making contact with a metallic surface (chassis, cabinet). Always operate the controller in a well ventilated space so that air can flow around the unit.

Sensor and Commands Connection

Connection to RC Radio, Microcomputer, Potentiometer, encoders and other low current sensors and actuators is done via the 25-pin DSub connectors and the 8-bit circular connector located at the top of the controller. The functions of many pins vary depending on controller configuration. Use mating connector Conxall/Switchcraft model 6282-8SG-3DC, or equivalent. Each encoder input includes a 4.7K pull up resistor and can therefore accommodate encoders with open collector/open drain outputs. A 1nF capacitor to ground is present on each input for noise reduction. Pin assignments are found in Tables 2 and 3, below.

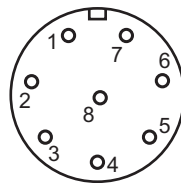

FIGURE 3. Circular Connector Pin Locations

TABLE 2.

Connector pin	Power	Encoder	DOUT	Default Configuration
1	+V5			
2		ENCA		Encoder A
3		ENCB		Encoder B
4				Unused
5				Unused
6			DOUT5 (1)	Digital output
7			DOUT6 (1)	Digital output
8	GND			

Note 1: Outputs are Open Drain. They pull to ground when on and float when off. Load must be connected between output and positive voltage.

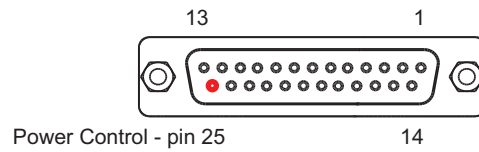

FIGURE 4. Main Connector Pin Locations

TABLE 3.

Connector Pin	Power	Dout	Com	Pulse	Ana	Dinput	Default Config
1	GND						
14	5VOut						
2			RSTxD				RS232Tx
15				RC1	ANA1	DIN1	RCRadio1
3			RS RxD				RS232Rx
16				RC2	ANA2	DIN2	RCRadio2
4				RC3	ANA3	DIN3	AnaCmd1 (1)
17				RC4	ANA4	DIN4	Unused
5	GND						
18		DOUT1 (2)					Motor Brake
6		DOUT2 (2)					Contactor
19		DOUT3 (2)					Unused
7		DOUT4 (2)					Unused
20			CANH				Unused
8			CANL				Unused
21				RC5	ANA5	DIN5	Unused
9					ASIN1	DIN9	Unused
22				RC6	ANA6	DIN6	Unused
10					ACOS1	DIN10	Unused
23			RS485+				RS485+
11			RS485-				RS485-
24				RC7	ANA7	DIN7	Unused
12				RC8	ANA8	DIN8	Unused
25	PwrCtrl						
13	GND						

Note 1: Analog command is disabled in factory default configuration.

Note 2: Outputs are Open Drain. They pull to ground when on and float when off. Load must be connected between output and positive voltage.

For use in environment where liquid particles or fine dust may present, the controller's cover is shaped for DSub connectors with waterproof hoods. Product references EDAC 627-230-025-010, CONEC 165X14839X or Assmann A-DS25-HOOD-WP.

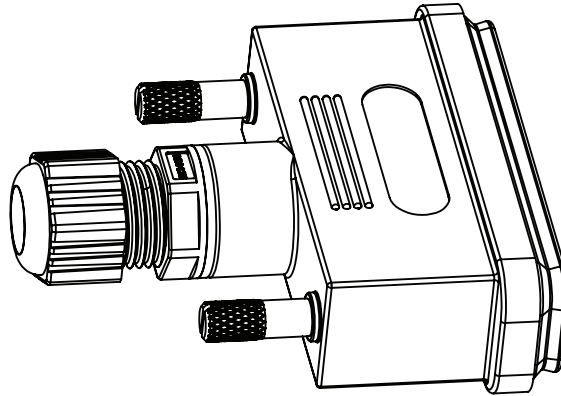

FIGURE 5. DSub Connector with Waterproof Hood

Enabling Analog Commands

For safety reasons, the Analog command mode is disabled by default. To enable the Analog mode, use the PC utility and set Analog in Command Priority 2 or 3 (leave Serial as priority 1). Note that by default the additional securities are enabled and will prevent the motor from starting unless the potentiometer is centered, or if the voltage is below 0.25V or above 4.75V. Use the PC utility to enable and assign analog inputs.

CAN Bus Operation

The controller can interface to a standard CAN Bus network, using 4 possible protocols: Standard CANOpen, a simple and efficient meshed networking scheme (RoboCAN), and two simplified proprietary schemes (MiniCAN and RawCAN). Please refer to the User Manual for details.

RS485 Communication

The RGIM18xx has a half-duplex RS485 interface. Two signals are present on the 25-pin DSub connector for connecting to RS485 networks. Connecting these two wires with the correct polarity is all that is needed to establish a connection. The RS485+ is the positive signal and RS485- is the inverted signal. Once enabled, the RS485 can be used to communicate data under the Modbus protocol, or Roboteq's native serial commands.

Status LEDs and Flashing Patterns

The controller is equipped with three LED indicators.



-  Communication LED
-  Power LED
-  Status LED

FIGURE 6. Status LEDs

After the controller is powered on, the Power LED will turn on, indicating that the controller is On. The Status LED will be flashing at a two second interval. The flashing pattern provides operating or exception status information.

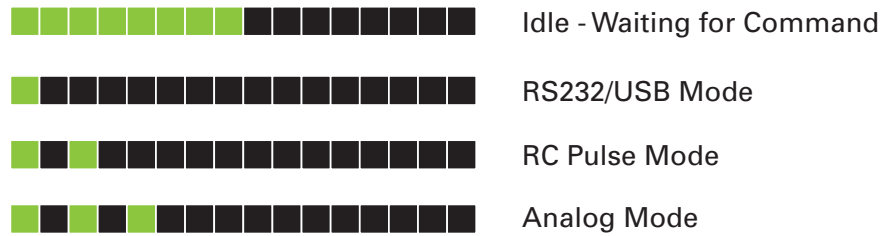

FIGURE 7. Normal Operation Flashing Patterns

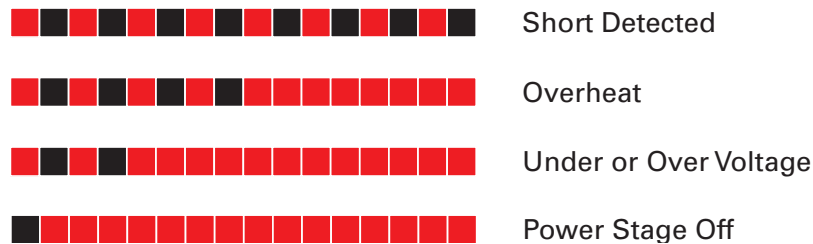

FIGURE 8. Exception or Fault Flashing Patterns

Additional status information may be obtained by monitoring the controller with the PC utility. The communication LED, as shown in Figure 9, gives status information on the CAN and USB.

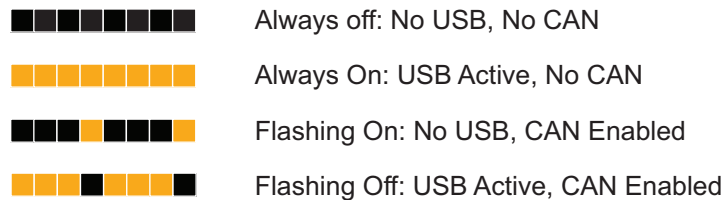

FIGURE 9. Communication LED

Battery Backed Clock and RAM

The controller includes a real-time clock/calendar and RAM storage for user variables. Both the clock and the RAM storage require a battery to continue running and for the stored data not to be lost while the controller is powered down. The battery is not installed by Roboteq. Users who wish to use the clock and/or battery backed RAM variables must install a battery themselves. The battery socket can be reached by removing the six screws that are holding the cover. Lift the cover to reach the board and insert a 3V, 12.5mm coin-style battery. Use battery type CR1225 or equivalent.

Measured Amps

Including Amps sensors on the wires allows for fast and efficient collection of information. Both Motor and Battery amps are measured in real-time.

Electrical Specifications

Absolute Maximum Values

The values in Table 4, below, should never be exceeded, permanent damage to the controller may result.

TABLE 4.

Parameter	Measure point	Model	Min	Typical	Max	Units
Battery Leads Voltage	Ground to VBat	RGIM1860			63	Volts
		RGIM1896			100	Volts
Reverse Voltage on Battery Leads	Ground to VBat	All	-1			Volts
Motor Leads Voltage	Ground to M+, M-	RGIM1860			63	Volts
		RGIM1896			100	Volts
Digital Output Voltage	Ground to Output pins	All			40	Volts
Power Control	Ground to PowerControl pin	All	-1		30	Volts
Analog and Digital Inputs Voltage	Ground to any signal pin on I/O connectors	All			25	Volts
RS232 pin Voltage	External voltage applied to Rx pin (2)	All	-25		25	Volts
CAN pins Voltage	External voltage applied to CANH/CANL pins	All	-25		25	Volts
Temperature	Board	All	-40		85	°C
Humidity	Board	All			100 (3)	%

Note 1: Maximum regeneration voltage in normal operation. Never inject a DC voltage from a battery or other fixed source.
 Note 2: Do not apply external voltage to Tx pin. Damage will occur.
 Note 3: Non-condensing.

Power Stage Electrical Specifications (at 25°C ambient)

TABLE 5.

Parameter	Measure point	Model	Min	Typical	Max	Units
Battery Leads Voltage	Ground to VBat	RGIM1860	10 (1)		63	Volts
		RGIM1896	40 (1)		100	Volts
Motor Leads Voltage	Ground to M+, M-	RGIM1860			63 (2)	Volts
		RGIM1896			100 (2)	Volts
Over Voltage protection range	Ground to VBat	RGIM1860			65 (2)	Volts
		RGIM1896		96	100 (2)	Volts
Under Voltage protection range	Ground to VBat	All	20	20 (4)		Volts

Parameter	Measure point	Model	Min	Typical	Max	Units
Idle Current Consumption	VBat or Pwr Ctrl wires	All		50 (5)	100	mA
ON Resistance (Excluding wire resistance)	VBat to A/B/C , plus A/B/C to Ground	All		0.7		mOhm
Max Current for 30s	Motor current	RGIM1860			300	Amps
		RGIM1896			300	Amps
Continuous Max Current	Motor current	RGIM1860			200 (6)	Amps
		RGIM1896			200 (6)	Amps
Current Limit range	Motor current	RGIM1860	10	200 (7)	300	Amps
		RGIM1896	10	200 (7)	300	Amps
Motor Acceleration/Deceleration range	Motor current	All	100	500 (8)	65000	milli-seconds

Note 1: Voltage may drop to 0 if backup supply is connected to Power Control pin. Negative voltage will cause a large surge current. Protection fuse needed if battery polarity inversion is possible.

Note 2: Maximum regeneration voltage in normal operation. Never inject a DC voltage from a battery or other fixed source.

Note 3: Minimum voltage must be present on VBat or Power Control wire.

Note 4: Factory default value. Adjustable in 0.1V increments.

Note 5: Current consumption is lower when higher voltage is applied to the controller's VBat or PwrCtrl wires.

Note 6: Estimate. Limited by heatsink temperature. Current may be higher with better cooling.

Note 7: Factory default value. Adjustable in 0.1A increments.

Note 8: Factory default value. Time in ms for power to go from 0 to 100%.

Command, I/O and Sensor Signals Specifications

TABLE 6.

Parameter	Measure point	Min	Typical	Max	Units
5V Out Voltage	Ground to 5V pin	4.8	5.1	5.2	Volts
5V Output Current	Output to ground			100	mA
Digital Output Voltage	Ground to Output pins			40	Volts
Digital Output Current	Output pins, sink current			1	Amps
Digital Input 0 Level	Ground to Input pins	-1		1	Volts
Digital Input 1 Level	Ground to Input pins	3		25	Volts
Analog Input Range	Ground to Input pins	0		5.1	Volts
Analog Input Precision	Ground to Input pins		0.5		%
Pulse durations	Pulse inputs	20000		10	us
Pulse repeat rate	Pulse inputs	50		250	Hz
Pulse Capture Resolution	Pulse inputs		1		us
Frequency Capture	Pulse inputs	100		2000	Hz
Encoder count	Internal	-2.147		2.147	10 ⁹ Counts
Encoder frequency	Encoder input pins			1M	Counts/s

Operating and Timing Specifications

TABLE 7.

Parameter	Measure Point	Min	Typical	Max	Units
Command Latency	Command to output change	0	1	2	ms
PWM Frequency	Motor outputs		16		kHz
Closed Loop update rate	Internal		1000		Hz
Serial baud rate	Rx and Tx pins		115200 (1)		Bits/s
Serial Watchdog timeout	Rx pin	1 (2)		65000	ms

Note 1: 115200, 8-bit, no parity, 1 stop bit, no flow control.

Note 2: May be disabled with value 0.

Scripting

TABLE 8.

Parameter	Measure Point	Min	Typical	Max	Units
Scripting Flash Memory	Internal		32000		Bytes
Max Basic Language programs	Internal	2000		3000	Lines
Integer Variables	Internal		4096		Words (1)
Boolean Variables	Internal		8192		Symbols
Execution Speed	Internal	50000	100000		Lines/s

Note 1: 32-bit words.

Thermal Specifications

TABLE 9.

Parameter	Measure Point	Min	Typical	Max	Units
Board Temperature	PCB	-40		85 (1)	°C
Thermal Protection range	PCB	70		80 (2)	°C
Thermal resistance	Power MOSFETs to heats sink			2	°C/W

Note 1: Thermal protection will protect the controller power.

Note 2: Max allowed power out starts lowering at minimum of range, down to 0 at max of range.

Mechanical Specifications

TABLE 10.

Parameter	Measure Point	Min	Typical	Max	Units
Weight	Unit		2940 (6.48)		g (lbs)
Power Terminals	Connection		M6 (1)		Thread

Note 1: Use M6 x 12mm long screws with washer between screw head and cable.

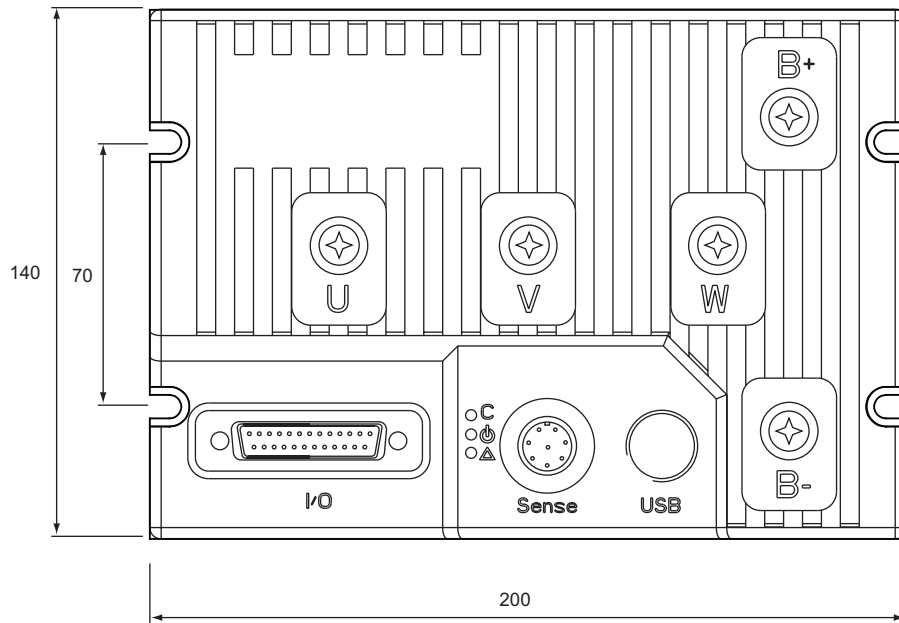

FIGURE 10. RGIM18xx Top View and Dimensions

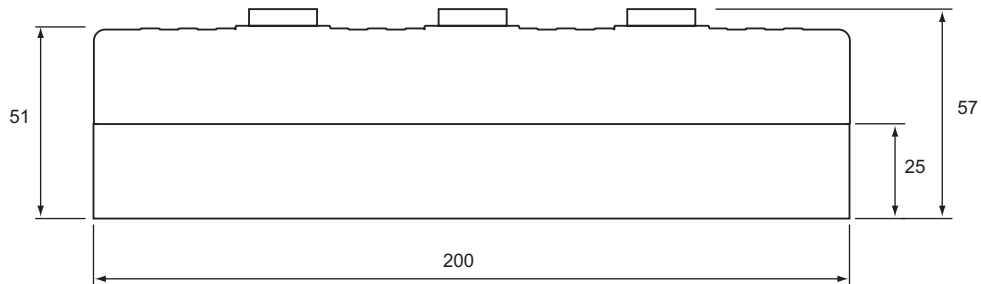

FIGURE 11. RGIM18xx Side View and Dimensions